

GEOMETRY

VOLUME OF PRISMS

VOLUME FORMULA OF A RECTANGULAR PRISM

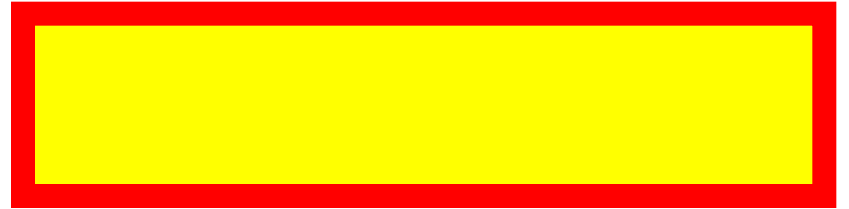

1) Find the volume:

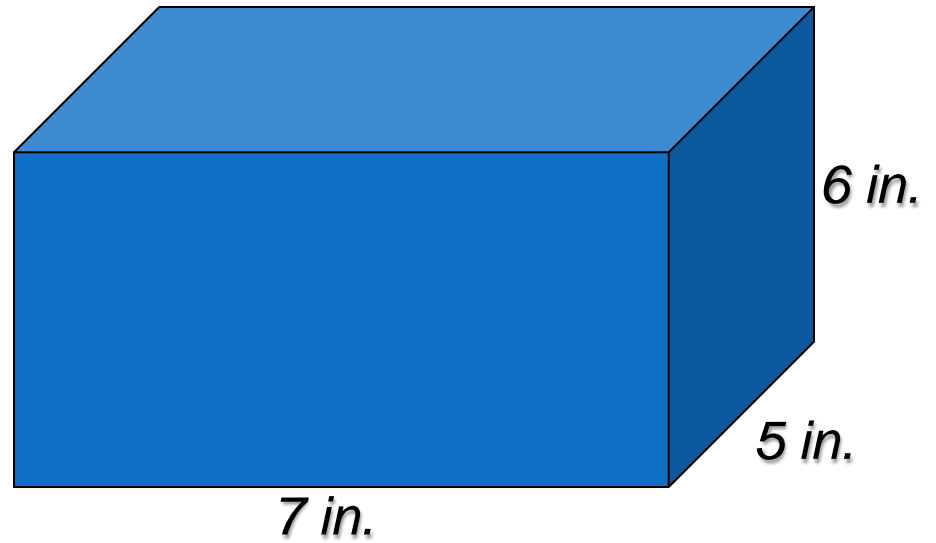

2) Find the volume:

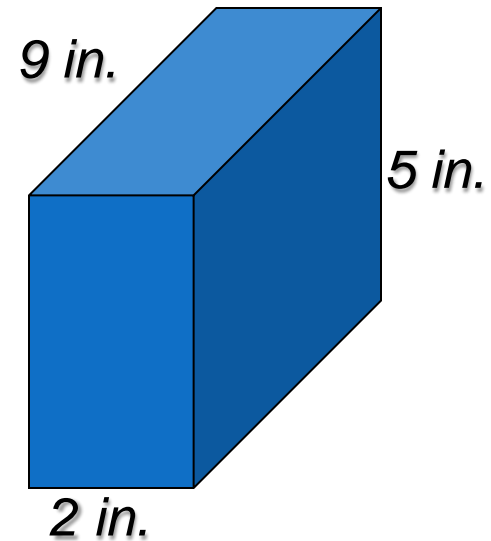

3) Find the missing side:

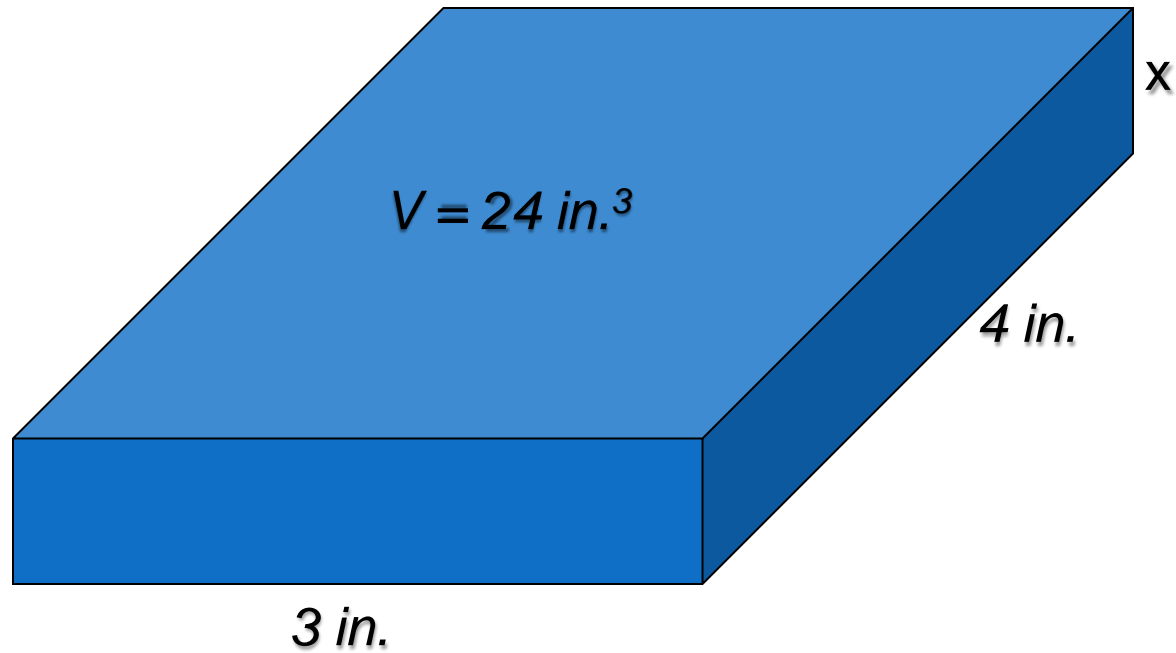

VOLUME FORMULA OF A TRIANGULAR PRISM

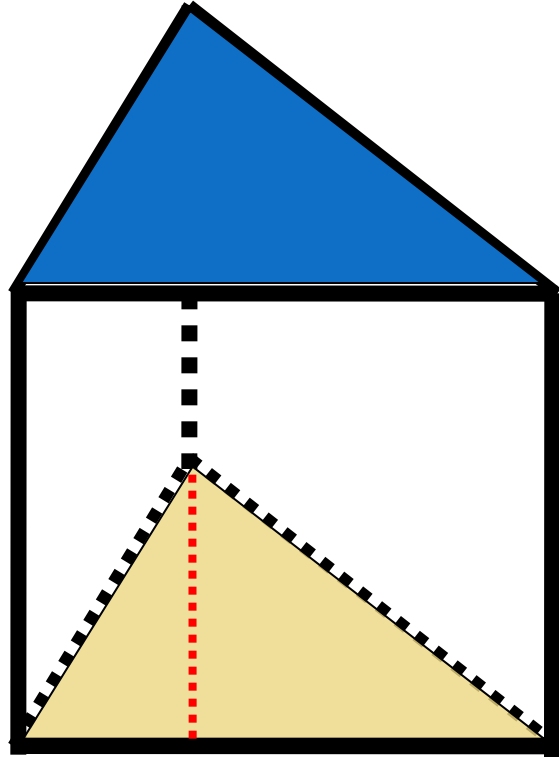

4) Find the Volume

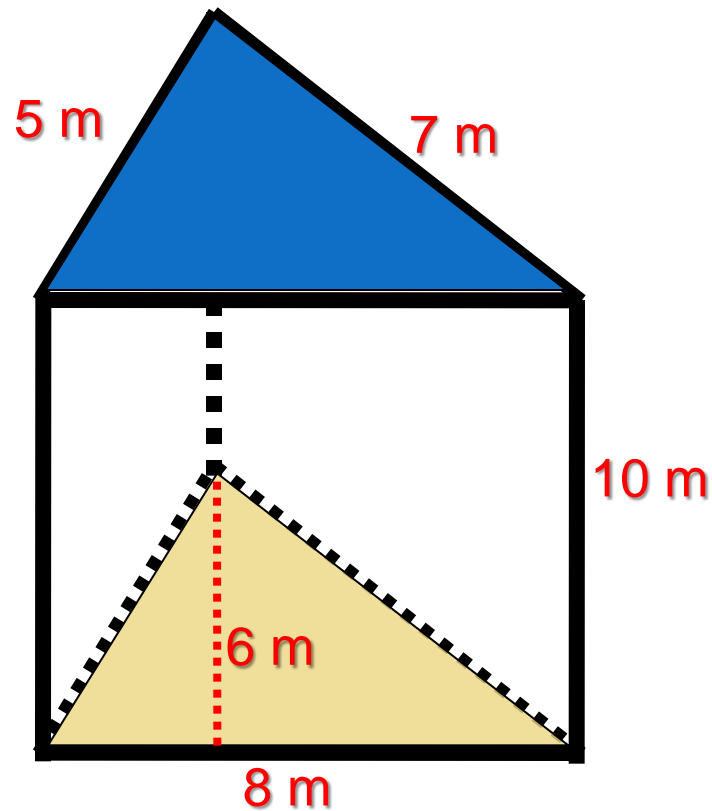

5) Find the Volume

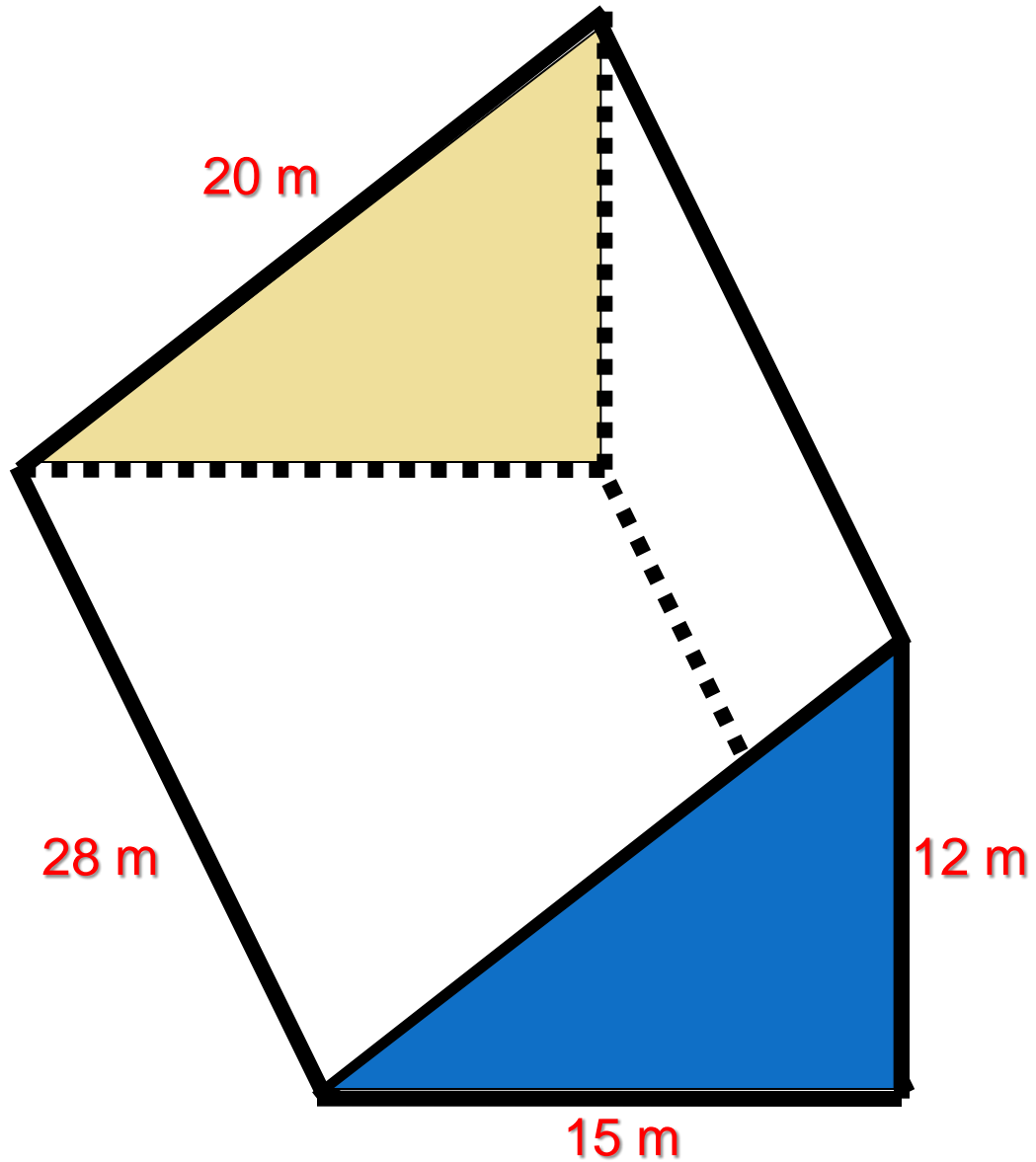

6) Find the Volume

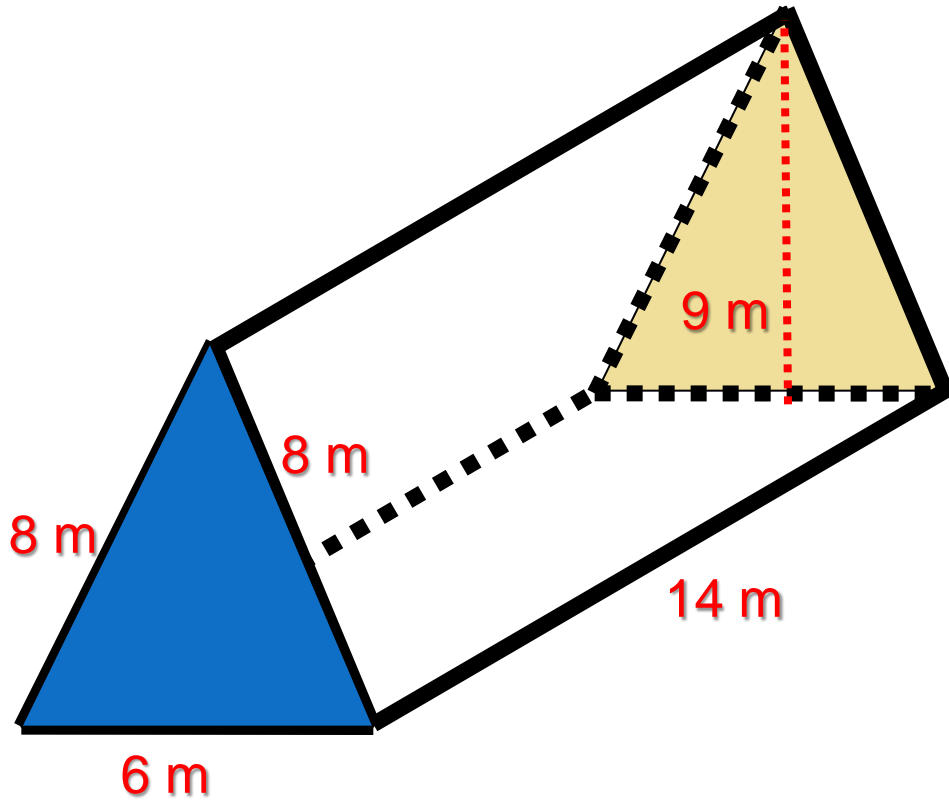

7) Find the Volume

